

**ALZANTI SCORREVOLI**  
LIFT&SLIDE

0

design Leo De Carlo

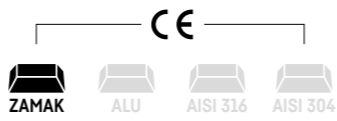

MANIGLIA PER ALZANTE SCORREVOLE - SUPPORTO 32x159x12mm\_LIFT&SLIDE HANDLE - SUPPORT 32x159x12mm

CARATTERISTICHE_FEATURES					FISSAGGIO_FIXING				FINITURE_FINISHES				OPZIONI_OPTIONS						

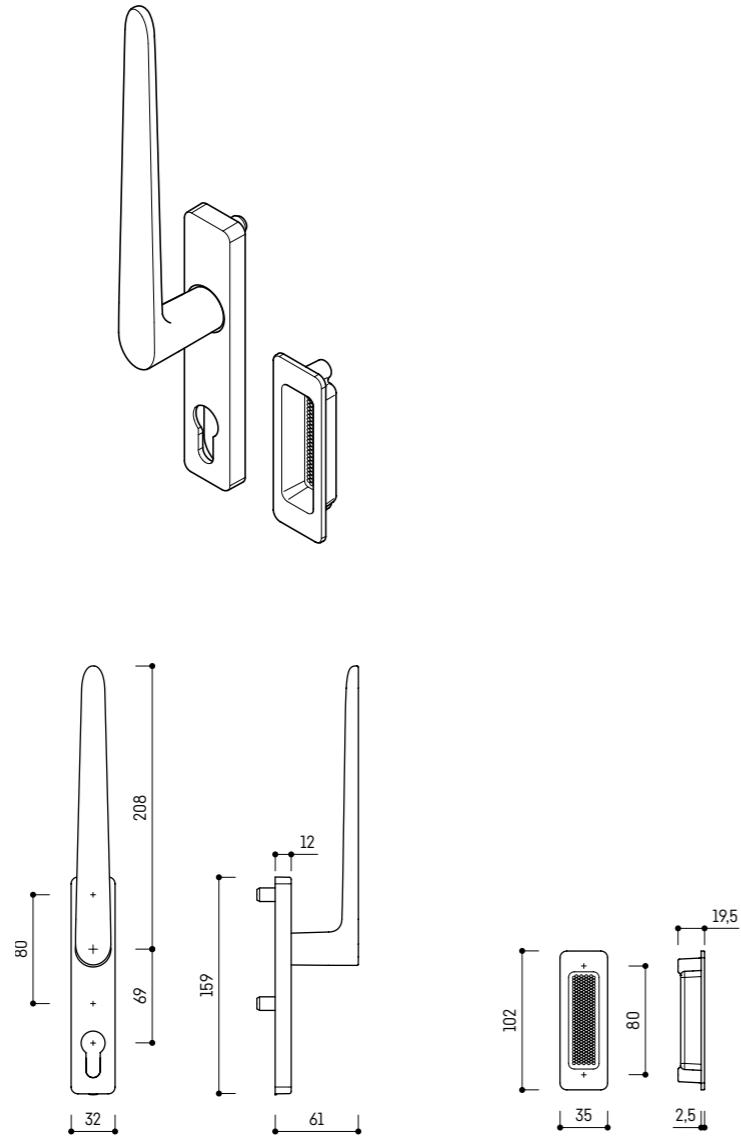

VERSIONI DISPONIBILI\_AVAILABLE VERSIONS

CAPITOLATO\_SPECIFICATION

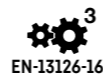

Per una descrizione dettagliata di tutte le specifiche tecniche presenti nel prodotto, da impiegare nei capitolati o nelle offerte pubbliche, fate riferimento alla sezione CAPITOLATI. For a detailed description of all the technical informations contained in the product, to be used in the specifications or in public tenders, please refer to the SPECIFICATIONS section.

NORMA EN 13126-16 \_EN 13126-16 NORM  
- 3 | 250 | 0 | 1 | 5 | - 16 | 1200 | 2000

0

design Leo De Carlo



ZAMAK

32x152x12mm (maniglia)

Supporto\_Support

												L						L L		
												PLATINUM	BLACK PEARL	PLATINUM	BLACK PEARL	COPPER PEARL	NOIR PEARL	ANTIQUE GOLD	COPPER SHINING	CRYSTAL SHINING
	10*			-	-	80	ø10x15	69	4	1	05919017									
	10*			-	-	80	ø10x15	-	4	1	05919018									
	10/75			75-80	M5x85 M5x90	80	ø10x15	69	4	1	05919019									
	10/75			75-80	M5x85 M5x90	80	ø10x15	-	4	1	05919020									

Opzioni\_Options

-



IRON

Supporto\_Support

Viti per maniglione singolo\_Screws for single L&S handle

												L	
												MECHANISM	26
	-	-		35-40	M5x45 M5x50	-	-	-	10	1	06828085		
	-	-		40-45	M5x50 M5x55	-	-	-	10	1	06828086		
	-	-		50-55	M5x60 M5x65	-	-	-	10	1	06828087		
	-	-		55-60	M5x65 M5x70	-	-	-	10	1	06828088		
	-	-		60-65	M5x70 M5x75	-	-	-	10	1	06828089		
	-	-		65-70	M5x75 M5x80	-	-	-	10	1	06828090		
	-	-		70-75	M5x80 M5x85	-	-	-	10	1	06828091		
	-	-		75-80	M5x85 M5x90	-	-	-	10	1	06828092		
	-	-		80-85	M5x90 M5x95	-	-	-	10	1	06828093		
	-	-		85-90	M5x95 M5x100	-	-	-	10	1	06828094		
	-	-		90-95	M5x100 M5x105	-	-	-	10	1	06828095		
	-	-		95-100	M5x105 M5x110	-	-	-	10	1	06828096		
	-	-		100-105	M5x110 M5x115	-	-	-	10	1	06828097		
	-	-		105-110	M5x115 M5x120	-	-	-	10	1	06828098		

Opzioni\_Options -



IRON

Supporto\_Support

Ferro per maniglione singolo\_Spindle for single L&amp;S handle

10/35	-	-	-	35-40	-	-	-	10	1	06727468		
10/40	-	-	-	40-45	-	-	-	10	1	06727469		
10/50	-	-	-	50-55	-	-	-	10	1	06727470		
10/55	-	-	-	55-60	-	-	-	10	1	06727471		
10/60	-	-	-	60-65	-	-	-	10	1	06727472		
10/65	-	-	-	65-70	-	-	-	10	1	06727473		
10/70	-	-	-	70-75	-	-	-	10	1	06727474		
10/75	-	-	-	75-80	-	-	-	10	1	06727475		
10/80	-	-	-	80-85	-	-	-	10	1	06727476		
10/85	-	-	-	85-90	-	-	-	10	1	06727477		
10/90	-	-	-	90-95	-	-	-	10	1	06727478		
10/95	-	-	-	95-100	-	-	-	10	1	06727479		
10/100	-	-	-	100-105	-	-	-	10	1	06727480		
10/105	-	-	-	105-110	-	-	-	10	1	06727481		

Opzioni\_Options -



IRON

Supporto\_Support

Ferro + viti per L&amp;S doppio\_Spindle + screws for double L&amp;S

10/85	-	-	-	35-40	M5x35 M5x40	-	-	-	10	1	06727478	
10/95	-	-	-	40-45	M5x40 M5x45	-	-	-	10	1	06727479	
10/100	-	-	-	45-50	M5x45 M5x50	-	-	-	10	1	06727480	
10/105	-	-	-	50-55	M5x50 M5x55	-	-	-	10	1	06727481	
10/110	-	-	-	55-60	M5x55 M5x60	-	-	-	10	1	06727482	
10/115	-	-	-	60-65	M5x60 M5x65	-	-	-	10	1	06727483	
10/120	-	-	-	65-70	M5x65 M5x70	-	-	-	10	1	06727484	
10/125	-	-	-	70-75	M5x70 M5x75	-	-	-	10	1	06727485	
10/130	-	-	-	75-80	M5x75 M5x80	-	-	-	10	1	06727486	
10/135	-	-	-	80-85	M5x80 M5x85	-	-	-	10	1	06727487	
10/140	-	-	-	85-90	M5x85 M5x90	-	-	-	10	1	06727488	
10/145	-	-	-	90-95	M5x90 M5x95	-	-	-	10	1	06727489	
10/150	-	-	-	95-100	M5x95 M5x100	-	-	-	10	1	06727490	
10/155	-	-	-	100-105	M5x100 M5x105	-	-	-	10	1	06727491	

## Maniglia doppia\_Double handle

design Leo De Carlo



ZAMAK

Supporto\_Support

32x159x12mm

10/128				75-80	M5x90	80	ø10x15	69	4	1	05919041		●	●	●	●	●	●	●	●	●

Manigletta da incasso singola  
Single recessed handle

design Leo De Carlo



ZAMAK

Supporto\_Support

32x102x2,5mm

-	-	-		-	-	80	-	-	-	4	1	05213026	●	●	●	●	●	●	●	●	●	●	●

0

design Leo De Carlo



CARATTERISTICHE_FEATURES				FISSAGGIO_FIXING				FINITURE_FINISHES				OPZIONI_OPTIONS							

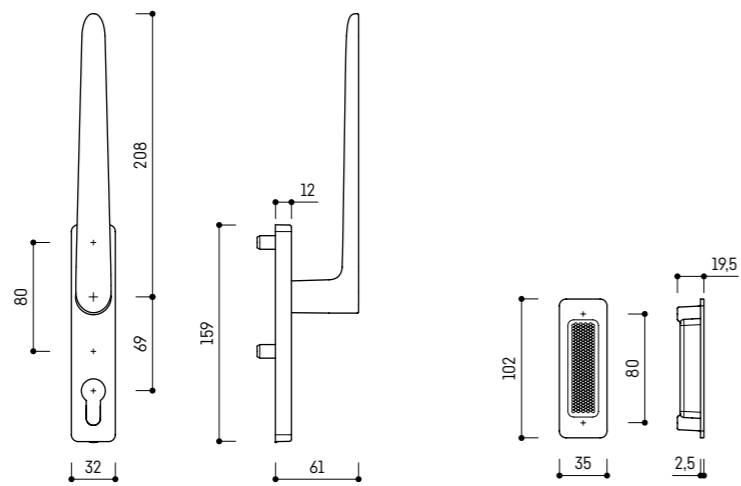
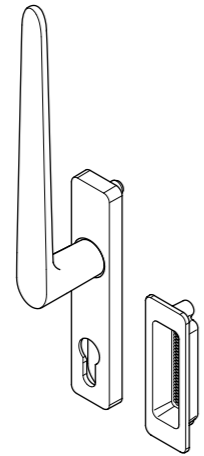

VERSIONI DISPONIBILI_AVAILABLE VERSIONS					CAPITOLATO_SPECIFICATION  EN-13126-16
					<p>Per una descrizione dettagliata di tutte le specifiche tecniche presenti nel prodotto, da impiegare nei capitolati o nelle offerte pubbliche, fate riferimento alla sezione CAPITOLATI for a detailed description of all the technical informations contained in the product, to be used in the specifications or in public tenders, please refer to the SPECIFICATIONS section.</p> <p><b>NORMA EN 13126-16</b> _EN 13126-16 NORM</p> <p>- 3   250   0   1   5   - 16   1200   2000</p>

0

design Leo De Carlo



ALU

32x159x12mm

Supporto\_Support

	10*			-	-	80	ø10x15	69	4	1	05919029								
	10*			-	-	80	ø10x15	-	4	1	05919030								
	10/75			75-80	M5x85 M5x90	80	ø10x15	69	4	1	05919031								
	10/75			75-80	M5x85 M5x90	80	ø10x15	-	4	1	05919032								

Opzioni\_Options

-



IRON

Supporto\_Support

Viti per maniglione singolo\_Screws for single L&S handle

	-	-		35-40	M5x45 M5x50	-	-	-	10	1	06828085								
	-	-		40-45	M5x50 M5x55	-	-	-	10	1	06828086								
	-	-		50-55	M5x60 M5x65	-	-	-	10	1	06828087								
	-	-		55-60	M5x65 M5x70	-	-	-	10	1	06828088								
	-	-		60-65	M5x70 M5x75	-	-	-	10	1	06828089								
	-	-		65-70	M5x75 M5x80	-	-	-	10	1	06828090								
	-	-		70-75	M5x80 M5x85	-	-	-	10	1	06828091								
	-	-		75-80	M5x85 M5x90	-	-	-	10	1	06828092								
	-	-		80-85	M5x90 M5x95	-	-	-	10	1	06828093								
	-	-		85-90	M5x95 M5x100	-	-	-	10	1	06828094								
	-	-		90-95	M5x100 M5x105	-	-	-	10	1	06828095								
	-	-		95-100	M5x105 M5x110	-	-	-	10	1	06828096								
	-	-		100-105	M5x110 M5x115	-	-	-	10	1	06828097								
	-	-		105-110	M5x115 M5x120	-	-	-	10	1	06828098								

Opzioni\_Options



IRON

Supporto\_Support

Ferro per maniglione singolo\_Spindle for single L&amp;S handle

												MECHANISM 26
10/35	-	-	35-40	-	-	-	-	10	1	06727468		●
10/40	-	-	40-45	-	-	-	-	10	1	06727469		●
10/50	-	-	50-55	-	-	-	-	10	1	06727470		●
10/55	-	-	55-60	-	-	-	-	10	1	06727471		●
10/60	-	-	60-65	-	-	-	-	10	1	06727466		●
10/65	-	-	65-70	-	-	-	-	10	1	06727472		●
10/70	-	-	70-75	-	-	-	-	10	1	06727473		●
10/75	-	-	75-80	-	-	-	-	10	1	06727340		●
10/80	-	-	80-85	-	-	-	-	10	1	06727474		●
10/85	-	-	85-90	-	-	-	-	10	1	06727475		●
10/90	-	-	90-95	-	-	-	-	10	1	06727399		●
10/95	-	-	95-100	-	-	-	-	10	1	06727476		●
10/100	-	-	100-105	-	-	-	-	10	1	06727477		●
10/105	-	-	105-110	-	-	-	-	10	1	06727137		●

## Maniglia doppia\_Double handle

design Leo De Carlo



ALU

Supporto\_Support

32x159x12mm

													F1 97	P2 48	BLACK MATT 9016 G6 33	WHITE SIGNAL 9014 G85 22	ANTHRAQITE 7014 G85 78
10/128			75-80	M5x90	80	ø10x15	69	4	1	05919044		●	●	●	●	●	

Opzioni\_Options



IRON

Supporto\_Support

Ferro + viti per L&amp;S doppio\_Spindle + screws for double L&amp;S

												MECHANISM 26
10/85	-	-	35-40	M5x35 M5x40	-	-	-	10	1	06727478		●
10/95	-	-	40-45	M5x40 M5x45	-	-	-	10	1	06727479		●
10/100	-	-	45-50	M5x45 M5x50	-	-	-	10	1	06727480		●
10/105	-	-	50-55	M5x50 M5x55	-	-	-	10	1	06727481		●
10/110	-	-	55-60	M5x55 M5x60	-	-	-	10	1	06727482		●
10/115	-	-	60-65	M5x60 M5x65	-	-	-	10	1	06727483		●
10/120	-	-	65-70	M5x65 M5x70	-	-	-	10	1	06727484		●
10/125	-	-	70-75	M5x70 M5x75	-	-	-	10	1	06727485		●
10/130	-	-	75-80	M5x75 M5x80	-	-	-	10	1	06727486		●
10/135	-	-	80-85	M5x80 M5x85	-	-	-	10	1	06727487		●
10/140	-	-	85-90	M5x85 M5x90	-	-	-	10	1	06727488		●
10/145	-	-	90-95	M5x90 M5x95	-	-	-	10	1	06727489		●
10/150	-	-	95-100	M5x95 M5x100	-	-	-	10	1	06727490		●
10/155	-	-	100-105	M5x100 M5x105	-	-	-	10	1	06727491		●

Manigletta da incasso singola  
Single recessed handle

design Leo De Carlo



ALU

Supporto\_Support

32x102x2,5mm

												F1 97	P2 48	BLACK MATT 9016 G6 33	WHITE SIGNAL 9014 G85 22	ANTHRAQITE 7014 G85 78
	-	-		-	-	80	-	-	4	1	05213024	●	●	●	●	●



## MANIGLIA PER ALZANTE SCORREVOLE - SUPPORTO 32x159x12mm\_LIFT&SLIDE HANDLE - SUPPORT 32x159x12mm

CARATTERISTICHE_FEATURES					FISSAGGIO_FIXING				FINITURE_FINISHES				OPZIONI_OPTIONS						

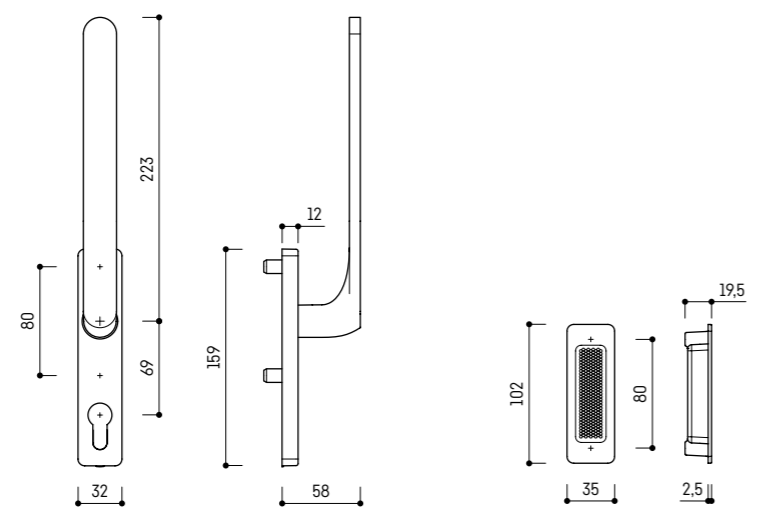
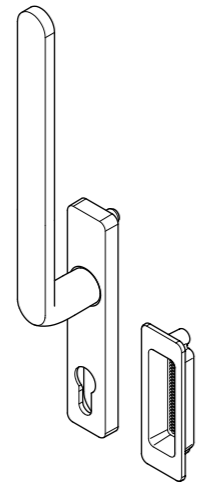

VERSIONI DISPONIBILI_AVAILABLE VERSIONS					CAPITOLATO_SPECIFICATION
					<p>Per una descrizione dettagliata di tutte le specifiche tecniche presenti nel prodotto, da impiegare nei capitolati o nelle offerte pubbliche, fate riferimento alla sezione CAPITOLATI. For a detailed description of all the technical informations contained in the product, to be used in the specifications or in public tenders, please refer to the SPECIFICATIONS section.</p> <p><b>NORMA EN 13126-16</b> _EN 13126-16 NORM</p> <p>- 3   250   0   1   5   - 16   1200   2000</p>



												MECHANISM						MECHANISM			
												PLATINUM	BLACK PEARL	PLATINUM	BLACK PEARL	COPPER PEARL	NOIR PEARL	ANTIQUE GOLD	COPPER SHINING	CRYSTAL SHINING	GOLD SHINING
	10*			-	-	80	ø10x15	69	4	1	05919058	62	50	03	04	5B	08	06	52	07	01
	10*			-	-	80	ø10x15	-	4	1	05919059	●	●	●	●	●	●	●	●	●	●
	10/75			75-80	M5x85 M5x90	80	ø10x15	69	4	1	05919060	●	●	●	●	●	●	●	●	●	●
	10/75			75-80	M5x85 M5x90	80	ø10x15	-	4	1	05919061	●	●	●	●	●	●	●	●	●	●



												MECHANISM										
												26										
	-	-		35-40	M5x45 M5x50	-	-	-	10	1	06828085	●	●	●	●	●	●	●	●	●	●	●
	-	-		40-45	M5x50 M5x55	-	-	-	10	1	06828086	●	●	●	●	●	●	●	●	●	●	●
	-	-		50-55	M5x60 M5x65	-	-	-	10	1	06828087	●	●	●	●	●	●	●	●	●	●	●
	-	-		55-60	M5x65 M5x70	-	-	-	10	1	06828088	●	●	●	●	●	●	●	●	●	●	●
	-	-		60-65	M5x70 M5x75	-	-	-	10	1	06828089	●	●	●	●	●	●	●	●	●	●	●
	-	-		65-70	M5x75 M5x80	-	-	-	10	1	06828090	●	●	●	●	●	●	●	●	●	●	●
	-	-		70-75	M5x80 M5x85	-	-	-	10	1	06828091	●	●	●	●	●	●	●	●	●	●	●
	-	-		75-80	M5x85 M5x90	-	-	-	10	1	06828092	●	●	●	●	●	●	●	●	●	●	●
	-	-		80-85	M5x90 M5x95	-	-	-	10	1	06828093	●	●	●	●	●	●	●	●	●	●	●
	-	-		85-90	M5x95 M5x100	-	-	-	10	1	06828094	●	●	●	●	●	●	●	●	●	●	●
	-	-		90-95	M5x100 M5x105	-	-	-	10	1	06828095	●	●	●	●	●	●	●	●	●	●	●
	-	-		95-100	M5x105 M5x110	-	-	-	10	1	06828096	●	●	●	●	●	●	●	●	●	●	●
	-	-		100-105	M5x110 M5x115	-	-	-	10	1	06828097	●	●	●	●	●	●	●	●	●	●	●
	-	-		105-110	M5x115 M5x120	-	-	-	10	1	06828098	●	●	●	●	●	●	●	●	●	●	●

Opzioni\_Options



IRON

Supporto\_Support

Ferro per maniglione singolo\_Spindle for single L&S handle

											MECHANISM
											26
10/35	-	-	35-40	-	-	-	-	10	1	06727468	
10/40	-	-	40-45	-	-	-	-	10	1	06727469	
10/50	-	-	50-55	-	-	-	-	10	1	06727470	
10/55	-	-	55-60	-	-	-	-	10	1	06727471	
10/60	-	-	60-65	-	-	-	-	10	1	06727166	
10/65	-	-	65-70	-	-	-	-	10	1	06727472	
10/70	-	-	70-75	-	-	-	-	10	1	06727473	
10/75	-	-	75-80	-	-	-	-	10	1	06727340	
10/80	-	-	80-85	-	-	-	-	10	1	06727474	
10/85	-	-	85-90	-	-	-	-	10	1	06727475	
10/90	-	-	90-95	-	-	-	-	10	1	06727399	
10/95	-	-	95-100	-	-	-	-	10	1	06727476	
10/100	-	-	100-105	-	-	-	-	10	1	06727477	
10/105	-	-	105-110	-	-	-	-	10	1	06727137	

Maniglia doppia\_Double handle

design Leo De Carlo



ZAMAK

Supporto\_Support

32x159x12mm

											L	L	L								
											PLATINUM	BLACK PEARL	PLATINUM	BLACK PEARL	COPPER PEARL	NOIR PEARL	ANTIQUÉ GOLD	COPPER SHINING	CRYSTAL SHINING	GOLD SHINING	
											62	50	03	04	5B	08	06	52	07	01	02
10/128			75-80	M5x90	80	ø10x15	69	4	1	05919062	●	●	●	●	●	●	●	●	●	●	●

Opzioni\_Options



IRON

Supporto\_Support

Ferro + viti per L&S doppio\_Spindle + screws for double L&S

											MECHANISM	
											26	
10/85	-	-	35-40	M5x35	M5x40	-	-	-	10	1	06727478	
10/95	-	-	40-45	M5x40	M5x45	-	-	-	10	1	06727479	
10/100	-	-	45-50	M5x45	M5x50	-	-	-	10	1	06727480	
10/105	-	-	50-55	M5x50	M5x55	-	-	-	10	1	06727481	
10/110	-	-	55-60	M5x55	M5x60	-	-	-	10	1	06727482	
10/115	-	-	60-65	M5x60	M5x65	-	-	-	10	1	06727483	
10/120	-	-	65-70	M5x65	M5x70	-	-	-	10	1	06727484	
10/125	-	-	70-75	M5x70	M5x75	-	-	-	10	1	06727485	
10/130	-	-	75-80	M5x75	M5x80	-	-	-	10	1	06727486	
10/135	-	-	80-85	M5x80	M5x85	-	-	-	10	1	06727487	
10/140	-	-	85-90	M5x85	M5x90	-	-	-	10	1	06727488	
10/145	-	-	90-95	M5x90	M5x95	-	-	-	10	1	06727489	
10/150	-	-	95-100	M5x95	M5x100	-	-	-	10	1	06727490	
10/155	-	-	100-105	M5x100	M5x105	-	-	-	10	1	06727491	

Maniglietta da incasso singola  
Single recessed handle

design Leo De Carlo



ZAMAK

Supporto\_Support

32x102x2,5mm

											L	L	L									
											PLATINUM	BLACK PEARL	PLATINUM	BLACK PEARL	COPPER PEARL	NOIR PEARL	ANTIQUÉ GOLD	COPPER SHINING	CRYSTAL SHINING	GOLD SHINING	NATURAL GOLD	WHITE PEARL
											62	50	03	04	5B	08	06	52	07	01	52	02
-	-								4	1	05213026	●	●	●	●	●	●	●	●	●	●	●



MANIGLIA PER ALZANTE SCORREVOLE - SUPPORTO 32x159x12mm\_LIFT&SLIDE HANDLE - SUPPORT 32x159x12mm

CARATTERISTICHE_FEATURES				FISSAGGIO_FIXING				FINITURE_FINISHES						OPZIONI_OPTIONS			

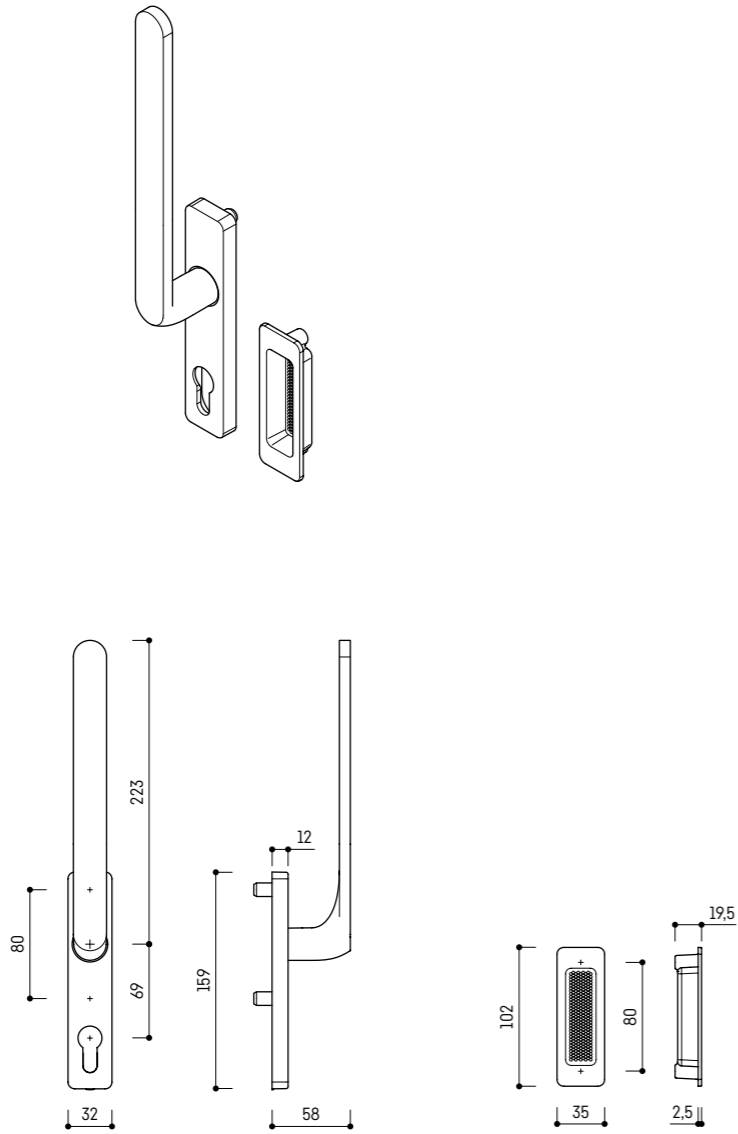

VERSIONI DISPONIBILI\_AVAILABLE VERSIONS

VERSIONI DISPONIBILI_AVAILABLE VERSIONS					CAPITOLATO_SPECIFICATION
					<b>EN-13126-16</b>
					<p>Per una descrizione dettagliata di tutte le specifiche tecniche presenti nel prodotto, da impiegare nei capitolati o nelle offerte pubbliche, fate riferimento alla sezione <b>CAPITOLATI</b> for a detailed description of all the technical informations contained in the product, to be used in the specifications or in public tenders, please refer to the SPECIFICATIONS section.</p> <p><b>NORMA EN 13126-16</b> _EN 13126-16 NORM</p> <p>- <b>3</b>   250   <b>0</b>   <b>1</b>   <b>5</b> -   <b>16</b>   1200   2000</p>



**ALU**

Supporto\_Support

32x159x12mm (maniglia)

																MECHANISM				
																F1	F9	BLACK MATT 9006 G6	WHITE SIGNAL 9006 G85	ANTHRACITE 7006 G85
																97	48	33	22	78
	10*			-	-	80	ø10x15	69	4	1	05919063	●	●	●	●	●	●	●	●	●
	10*			-	-	80	ø10x15	-	4	1	05919064	●	●	●	●	●	●	●	●	●
	10/75			75-80	M5x85 M5x90	80	ø10x15	69	4	1	05919065	●	●	●	●	●	●	●	●	●
	10/75			75-80	M5x85 M5x90	80	ø10x15	-	4	1	05919066	●	●	●	●	●	●	●	●	●

Opzioni\_Options

-



**IRON**

Supporto\_Support

Viti per maniglione singolo\_Screws for single L&S handle

																MECHANISM
	-	-		35-40	M5x45 M5x50	-	-	-	10	1	06828085	●				
	-	-		40-45	M5x50 M5x55	-	-	-	10	1	06828086	●				
	-	-		50-55	M5x60 M5x65	-	-	-	10	1	06828087	●				
	-	-		55-60	M5x65 M5x70	-	-	-	10	1	06828088	●				
	-	-		60-65	M5x70 M5x75	-	-	-	10	1	06828089	●				
	-	-		65-70	M5x75 M5x80	-	-	-	10	1	06828090	●				
	-	-		70-75	M5x80 M5x85	-	-	-	10	1	06828091	●				
	-	-		75-80	M5x85 M5x90	-	-	-	10	1	06828092	●				
	-	-		80-85	M5x90 M5x95	-	-	-	10	1	06828093	●				
	-	-		85-90	M5x95 M5x100	-	-	-	10	1	06828094	●				
	-	-		90-95	M5x100 M5x105	-	-	-	10	1	06828095	●				
	-	-		95-100	M5x105 M5x110	-	-	-	10	1	06828096	●				
	-	-		100-105	M5x110 M5x115	-	-	-	10	1	06828097	●				
	-	-		105-110	M5x115 M5x120	-	-	-	10	1	06828098	●				



Opzioni\_Options



IRON

Supporto\_Support

Ferro per maniglione singolo\_Spindle for single L&amp;S handle

												MECHANISM 26
10/35	-	-	35-40	-	-	-	-	10	1	06727468		●
10/40	-	-	40-45	-	-	-	-	10	1	06727469		●
10/50	-	-	50-55	-	-	-	-	10	1	06727470		●
10/55	-	-	55-60	-	-	-	-	10	1	06727471		●
10/60	-	-	60-65	-	-	-	-	10	1	06727466		●
10/65	-	-	65-70	-	-	-	-	10	1	06727472		●
10/70	-	-	70-75	-	-	-	-	10	1	06727473		●
10/75	-	-	75-80	-	-	-	-	10	1	06727340		●
10/80	-	-	80-85	-	-	-	-	10	1	06727474		●
10/85	-	-	85-90	-	-	-	-	10	1	06727475		●
10/90	-	-	90-95	-	-	-	-	10	1	06727399		●
10/95	-	-	95-100	-	-	-	-	10	1	06727476		●
10/100	-	-	100-105	-	-	-	-	10	1	06727477		●
10/105	-	-	105-110	-	-	-	-	10	1	06727137		●

## Maniglia doppia\_Double handle

design Leo De Carlo



ALU

Supporto\_Support

32x159x12mm

												F1 97	P2 48	BLACK MATT 9016 G6 33	WHITE SIGNAL 9014 G85 22	ANTHRACITE 7014 G85 78
10/128			75-80	M5x90	80	ø10x15	69	4	1	05919067	●	●	●	●	●	●

Opzioni\_Options



IRON

Supporto\_Support

Ferro + viti per L&amp;S doppio\_Spindle + screws for double L&amp;S

											MECHANISM 26
10/85	-	-	35-40	M5x35 M5x40	-	-	-	10	1	06727478	●
10/95	-	-	40-45	M5x40 M5x45	-	-	-	10	1	06727479	●
10/100	-	-	45-50	M5x45 M5x50	-	-	-	10	1	06727480	●
10/105	-	-	50-55	M5x50 M5x55	-	-	-	10	1	06727481	●
10/110	-	-	55-60	M5x55 M5x60	-	-	-	10	1	06727482	●
10/115	-	-	60-65	M5x60 M5x65	-	-	-	10	1	06727483	●
10/120	-	-	65-70	M5x65 M5x70	-	-	-	10	1	06727484	●
10/125	-	-	70-75	M5x70 M5x75	-	-	-	10	1	06727485	●
10/130	-	-	75-80	M5x75 M5x80	-	-	-	10	1	06727486	●
10/135	-	-	80-85	M5x80 M5x85	-	-	-	10	1	06727487	●
10/140	-	-	85-90	M5x85 M5x90	-	-	-	10	1	06727488	●
10/145	-	-	90-95	M5x90 M5x95	-	-	-	10	1	06727489	●
10/150	-	-	95-100	M5x95 M5x100	-	-	-	10	1	06727490	●
10/155	-	-	100-105	M5x100 M5x105	-	-	-	10	1	06727491	●

Manigletta da incasso singola  
Single recessed handle

design Leo De Carlo



ALU

Supporto\_Support

32x102x2,5mm

										F1 97	P2 48	BLACK MATT 9016 G6 33	WHITE SIGNAL 9014 G85 22	ANTHRACITE 7014 G85 78	
	-	-		-	-	80	-	4	1	05213024	●	●	●	●	●

# ARCO\_SAFETY

design Leo De Carlo

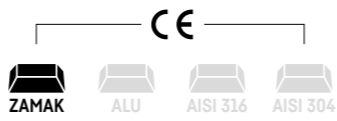

MANIGLIA PER ALZANTE SCORREVOLE - SUPPORTO 32x159x12mm\_LIFT&SLIDE HANDLE - SUPPORT 32x159x12mm

CARATTERISTICHE_FEATURES					FISSAGGIO_FIXING				FINITURE_FINISHES				OPZIONI_OPTIONS						

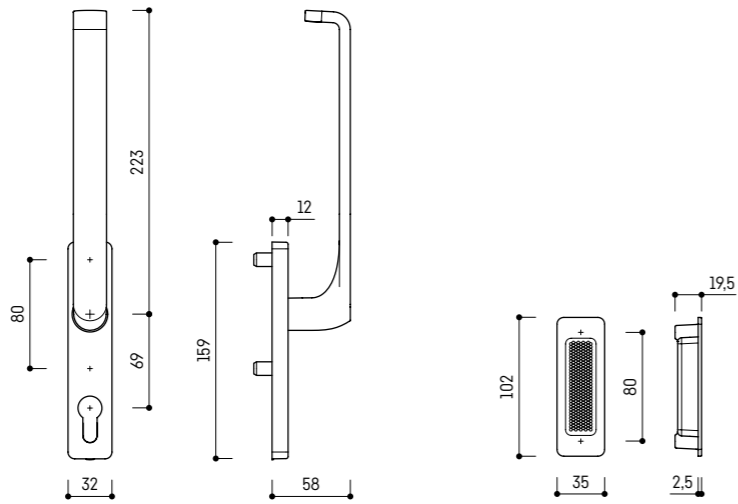
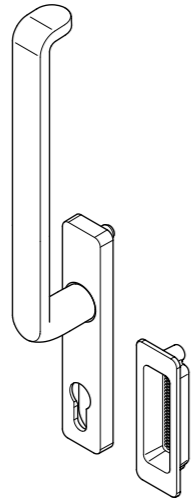

VERSIONI DISPONIBILI\_AVAILABLE VERSIONS

CAPITOLATO\_SPECIFICATION



Per una descrizione dettagliata di tutte le specifiche tecniche presenti nel prodotto, da impiegare nei capitolati o nelle offerte pubbliche, fate riferimento alla sezione CAPITOLATI. For a detailed description of all the technical informations contained in the product, to be used in the specifications or in public tenders, please refer to the SPECIFICATIONS section.

NORMA EN 13126-16 \_EN 13126-16 NORM

- 3 | 250 | 0 | 1 | 5 | - 16 | 1200 | 2000

# ARCO\_SAFETY

design Leo De Carlo



ZAMAK

Supporto\_Support

32x159x12mm (maniglia)

											MECHANISM						MECHANISM			
											62	50	03	04	5B	08	06	52	07	01
	10*			-	-	80	ø10x15	69	4	1	05919025	●	●	●	●	●	●	●	●	●
	10*			-	-	80	ø10x15	-	4	1	05919026	●	●	●	●	●	●	●	●	●
	10/75			75-80	M5x85 M5x90	80	ø10x15	69	4	1	05919027	●	●	●	●	●	●	●	●	●
	10/75			75-80	M5x85 M5x90	80	ø10x15	-	4	1	05919028	●	●	●	●	●	●	●	●	●

Opzioni\_Options

-



IRON

Supporto\_Support

Viti per maniglione singolo\_Screws for single L&S handle

												MECHANISM										
												26										
	-	-		35-40	M5x45 M5x50	-	-	-	10	1	06828085	●	●	●	●	●	●	●	●	●	●	●
	-	-		40-45	M5x50 M5x55	-	-	-	10	1	06828086	●	●	●	●	●	●	●	●	●	●	●
	-	-		50-55	M5x60 M5x65	-	-	-	10	1	06828087	●	●	●	●	●	●	●	●	●	●	●
	-	-		55-60	M5x65 M5x70	-	-	-	10	1	06828088	●	●	●	●	●	●	●	●	●	●	●
	-	-		60-65	M5x70 M5x75	-	-	-	10	1	06828089	●	●	●	●	●	●	●	●	●	●	●
	-	-		65-70	M5x75 M5x80	-	-	-	10	1	06828090	●	●	●	●	●	●	●	●	●	●	●
	-	-		70-75	M5x80 M5x85	-	-	-	10	1	06828091	●	●	●	●	●	●	●	●	●	●	●
	-	-		75-80	M5x85 M5x90	-	-	-	10	1	06828092	●	●	●	●	●	●	●	●	●	●	●
	-	-		80-85	M5x90 M5x95	-	-	-	10	1	06828093	●	●	●	●	●	●	●	●	●	●	●
	-	-		85-90	M5x95 M5x100	-	-	-	10	1	06828094	●	●	●	●	●	●	●	●	●	●	●
	-	-		90-95	M5x100 M5x105	-	-	-	10	1	06828095	●	●	●	●	●	●	●	●	●	●	●
	-	-		95-100	M5x105 M5x110	-	-	-	10	1	06828096	●	●	●	●	●	●	●	●	●	●	●
	-	-		100-105	M5x110 M5x115	-	-	-	10	1	06828097	●	●	●	●	●	●	●	●	●	●	●
	-	-		105-110	M5x115 M5x120	-	-	-	10	1	06828098	●	●	●	●	●	●	●	●	●	●	●

Opzioni\_Options -



IRON

Supporto\_Support

Ferro per maniglione singolo\_Spindle for single L&S handle

												MECHANISM 26
10/35	-	-	-	35-40	-	-	-	-	10	1	06727468	●
10/40	-	-	-	40-45	-	-	-	-	10	1	06727469	●
10/50	-	-	-	50-55	-	-	-	-	10	1	06727470	●
10/55	-	-	-	55-60	-	-	-	-	10	1	06727471	●
10/60	-	-	-	60-65	-	-	-	-	10	1	06727166	●
10/65	-	-	-	65-70	-	-	-	-	10	1	06727472	●
10/70	-	-	-	70-75	-	-	-	-	10	1	06727473	●
10/75	-	-	-	75-80	-	-	-	-	10	1	06727340	●
10/80	-	-	-	80-85	-	-	-	-	10	1	06727474	●
10/85	-	-	-	85-90	-	-	-	-	10	1	06727475	●
10/90	-	-	-	90-95	-	-	-	-	10	1	06727399	●
10/95	-	-	-	95-100	-	-	-	-	10	1	06727476	●
10/100	-	-	-	100-105	-	-	-	-	10	1	06727477	●
10/105	-	-	-	105-110	-	-	-	-	10	1	06727137	●

Opzioni\_Options -



IRON

Supporto\_Support

Ferro + viti per L&S doppio\_Spindle + screws for double L&S

												MECHANISM 26
10/85	-	-	-	35-40	-	-	-	-	10	1	06727478	●
10/95	-	-	-	40-45	-	-	-	-	10	1	06727479	●
10/100	-	-	-	45-50	-	-	-	-	10	1	06727480	●
10/105	-	-	-	50-55	-	-	-	-	10	1	06727481	●
10/110	-	-	-	55-60	-	-	-	-	10	1	06727482	●
10/115	-	-	-	60-65	-	-	-	-	10	1	06727483	●
10/120	-	-	-	65-70	-	-	-	-	10	1	06727484	●
10/125	-	-	-	70-75	-	-	-	-	10	1	06727485	●
10/130	-	-	-	75-80	-	-	-	-	10	1	06727486	●
10/135	-	-	-	80-85	-	-	-	-	10	1	06727487	●
10/140	-	-	-	85-90	-	-	-	-	10	1	06727488	●
10/145	-	-	-	90-95	-	-	-	-	10	1	06727489	●
10/150	-	-	-	95-100	-	-	-	-	10	1	06727490	●
10/155	-	-	-	100-105	-	-	-	-	10	1	06727491	●

Maniglia doppia\_Double handle

design Leo De Carlo



ZAMAK

Supporto\_Support

32x159x12mm

10/128				75-80	M5x90	80	ø10x15	69	4	1	05919043	●	PLATINUM 62	BLACK PEARL 50
													PLATINUM 03	BLACK PEARL 04
													COPPER PEARL 5B	NOIR PEARL 08
													ANTIQUE GOLD 06	COPPER SHINING 52
													CRYSTAL SHINING 07	GOLD SHINING 01

Maniglia da incasso singola  
Single recessed handle

design Leo De Carlo



ZAMAK

Supporto\_Support

32x102x2,5mm

-	-		-	-	80	-	-	-	4	1	05213026	●	PLATINUM 62	BLACK PEARL 50
													PLATINUM 03	BLACK PEARL 04
													COPPER PEARL 5B	NOIR PEARL 08
													ANTIQUE GOLD 06	COPPER SHINING 52
													CRYSTAL SHINING 07	GOLD SHINING 01
													NATURAL GOLD 52	WHITE PEARL 02

# ARCO\_SAFETY

design Leo De Carlo



MANIGLIA PER ALZANTE SCORREVOLE - SUPPORTO 32x159x12mm\_LIFT&SLIDE HANDLE - SUPPORT 32x159x12mm

CARATTERISTICHE_FEATURES					FISSAGGIO_FIXING					FINITURE_FINISHES					OPZIONI_OPTIONS					
8	CLAG	R	100	[Icon]	[Icon]	[Icon]	[Icon]	[Icon]	[Icon]	CLASS 5	CLASS 5	CLASS 5	CLASS 5	CLASS 5	CLASS 5	[Icon]	[Icon]	REI-60	EN-179	IP-65

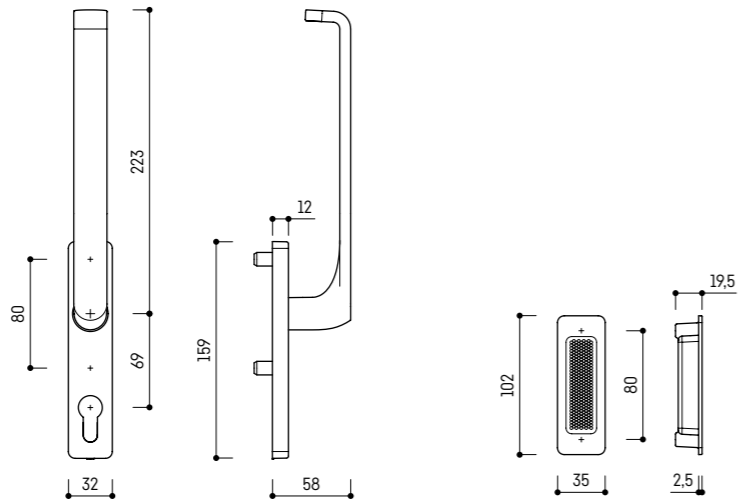
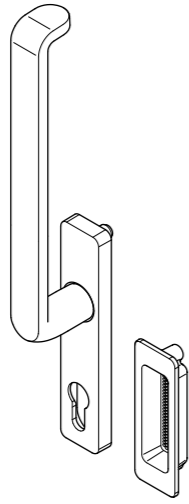

VERSIONI DISPONIBILI\_AVAILABLE VERSIONS

VERSIONI DISPONIBILI_AVAILABLE VERSIONS					CAPITOLATO_SPECIFICATION
[Icon]	[Icon]	[Icon]	[Icon]	[Icon]	Per una descrizione dettagliata di tutte le specifiche tecniche presenti nel prodotto, da impiegare nei capitolati o nelle offerte pubbliche, fate riferimento alla sezione CAPITOLATI for a detailed description of all the technical informations contained in the product, to be used in the specifications or in public tenders, please refer to the SPECIFICATIONS section.  <b>NORMA EN 13126-16</b> _EN 13126-16 NORM - 3   250   0   1   5   -   16   1200   2000
[Icon]					

# ARCO\_SAFETY

design Leo De Carlo



ALU

Supporto\_Support

32x159x12mm (maniglia)

[Icon]	10*	[Icon]	[Icon]	-	-	80	ø10x15	69	4	1	05919053	[Icon]	[Icon]	[Icon]	[Icon]	[Icon]	[Icon]	[Icon]	[Icon]	[Icon]	[Icon]
[Icon]	10*	[Icon]	[Icon]	-	-	80	ø10x15	-	4	1	05919054	[Icon]	[Icon]	[Icon]	[Icon]	[Icon]	[Icon]	[Icon]	[Icon]	[Icon]	[Icon]
[Icon]	10/75	[Icon]	[Icon]	75-80	M5x85 M5x90	80	ø10x15	69	4	1	05919055	[Icon]	[Icon]	[Icon]	[Icon]	[Icon]	[Icon]	[Icon]	[Icon]	[Icon]	[Icon]
[Icon]	10/75	[Icon]	[Icon]	75-80	M5x85 M5x90	80	ø10x15	-	4	1	05919056	[Icon]	[Icon]	[Icon]	[Icon]	[Icon]	[Icon]	[Icon]	[Icon]	[Icon]	[Icon]

Opzioni\_Options

-



IRON

Supporto\_Support

Viti per maniglione singolo\_Screws for single L&S handle

[Icon]	-	-	[Icon]	35-40	M5x45 M5x50	-	-	-	10	1	06828085	[Icon]	[Icon]	[Icon]	[Icon]	[Icon]	[Icon]	[Icon]	[Icon]	[Icon]	[Icon]
	-	-	[Icon]	40-45	M5x50 M5x55	-	-	-	10	1	06828086	[Icon]	[Icon]	[Icon]	[Icon]	[Icon]	[Icon]	[Icon]	[Icon]	[Icon]	[Icon]
	-	-	[Icon]	50-55	M5x60 M5x65	-	-	-	10	1	06828087	[Icon]	[Icon]	[Icon]	[Icon]	[Icon]	[Icon]	[Icon]	[Icon]	[Icon]	[Icon]
	-	-	[Icon]	55-60	M5x65 M5x70	-	-	-	10	1	06828088	[Icon]	[Icon]	[Icon]	[Icon]	[Icon]	[Icon]	[Icon]	[Icon]	[Icon]	[Icon]
	-	-	[Icon]	60-65	M5x70 M5x75	-	-	-	10	1	06828089	[Icon]	[Icon]	[Icon]	[Icon]	[Icon]	[Icon]	[Icon]	[Icon]	[Icon]	[Icon]
	-	-	[Icon]	65-70	M5x75 M5x80	-	-	-	10	1	06828090	[Icon]	[Icon]	[Icon]	[Icon]	[Icon]	[Icon]	[Icon]	[Icon]	[Icon]	[Icon]
	-	-	[Icon]	70-75	M5x80 M5x85	-	-	-	10	1	06828091	[Icon]	[Icon]	[Icon]	[Icon]	[Icon]	[Icon]	[Icon]	[Icon]	[Icon]	[Icon]
	-	-	[Icon]	75-80	M5x85 M5x90	-	-	-	10	1	06828092	[Icon]	[Icon]	[Icon]	[Icon]	[Icon]	[Icon]	[Icon]	[Icon]	[Icon]	[Icon]
	-	-	[Icon]	80-85	M5x90 M5x95	-	-	-	10	1	06828093	[Icon]	[Icon]	[Icon]	[Icon]	[Icon]	[Icon]	[Icon]	[Icon]	[Icon]	[Icon]
	-	-	[Icon]	85-90	M5x95 M5x100	-	-	-	10	1	06828094	[Icon]	[Icon]	[Icon]	[Icon]	[Icon]	[Icon]	[Icon]	[Icon]	[Icon]	[Icon]
	-	-	[Icon]	90-95	M5x100 M5x105	-	-	-	10	1	06828095	[Icon]	[Icon]	[Icon]	[Icon]	[Icon]	[Icon]	[Icon]	[Icon]	[Icon]	[Icon]
	-	-	[Icon]	95-100	M5x105 M5x110	-	-	-	10	1	06828096	[Icon]	[Icon]	[Icon]	[Icon]	[Icon]	[Icon]	[Icon]	[Icon]	[Icon]	[Icon]
	-	-	[Icon]	100-105	M5x110 M5x115	-	-	-	10	1	06828097	[Icon]	[Icon]	[Icon]	[Icon]	[Icon]	[Icon]	[Icon]	[Icon]	[Icon]	[Icon]
	-	-	[Icon]	105-110	M5x115 M5x120	-	-	-	10	1	06828098	[Icon]	[Icon]	[Icon]	[Icon]	[Icon]	[Icon]	[Icon]	[Icon]	[Icon]	[Icon]

Opzioni\_Options



IRON

Supporto\_Support

Ferro per maniglione singolo\_Spindle for single L&amp;S handle

												MECHANISM 26
10/35	-	-	35-40	-	-	-	-	10	1	06727468		
10/40	-	-	40-45	-	-	-	-	10	1	06727469		
10/50	-	-	50-55	-	-	-	-	10	1	06727470		
10/55	-	-	55-60	-	-	-	-	10	1	06727471		
10/60	-	-	60-65	-	-	-	-	10	1	06727466		
10/65	-	-	65-70	-	-	-	-	10	1	06727472		
10/70	-	-	70-75	-	-	-	-	10	1	06727473		
10/75	-	-	75-80	-	-	-	-	10	1	06727340		
10/80	-	-	80-85	-	-	-	-	10	1	06727474		
10/85	-	-	85-90	-	-	-	-	10	1	06727475		
10/90	-	-	90-95	-	-	-	-	10	1	06727399		
10/95	-	-	95-100	-	-	-	-	10	1	06727476		
10/100	-	-	100-105	-	-	-	-	10	1	06727477		
10/105	-	-	105-110	-	-	-	-	10	1	06727137		

Opzioni\_Options



IRON

Supporto\_Support

Ferro + viti per L&amp;S doppio\_Spindle + screws for double L&amp;S

												MECHANISM 26
10/85	-	-	35-40	M5x35 M5x40	-	-	-	10	1	06727478		
10/95	-	-	40-45	M5x40 M5x45	-	-	-	10	1	06727479		
10/100	-	-	45-50	M5x45 M5x50	-	-	-	10	1	06727480		
10/105	-	-	50-55	M5x50 M5x55	-	-	-	10	1	06727481		
10/110	-	-	55-60	M5x55 M5x60	-	-	-	10	1	06727482		
10/115	-	-	60-65	M5x60 M5x65	-	-	-	10	1	06727483		
10/120	-	-	65-70	M5x65 M5x70	-	-	-	10	1	06727484		
10/125	-	-	70-75	M5x70 M5x75	-	-	-	10	1	06727485		
10/130	-	-	75-80	M5x75 M5x80	-	-	-	10	1	06727486		
10/135	-	-	80-85	M5x80 M5x85	-	-	-	10	1	06727487		
10/140	-	-	85-90	M5x85 M5x90	-	-	-	10	1	06727488		
10/145	-	-	90-95	M5x90 M5x95	-	-	-	10	1	06727489		
10/150	-	-	95-100	M5x95 M5x100	-	-	-	10	1	06727490		
10/155	-	-	100-105	M5x100 M5x105	-	-	-	10	1	06727491		

## Maniglia doppia\_Double handle

design Leo De Carlo



ALU

Supporto\_Support

32x159x12mm

												F1 97	P2 48	BLACK MATT 9016 G6 33	WHITE SIGNAL 9014 G85 22	ANTHRACITE 7014 G85 78
10/128			75-80	M5x90	80	ø10x15	69	4	1	05919057	●	●	●	●	●	

Manigletta da incasso singola  
Single recessed handle

design Leo De Carlo



ALU

Supporto\_Support

32x102x2,5mm

												F1 97	P2 48	BLACK MATT 9016 G6 33	WHITE SIGNAL 9014 G85 22	ANTHRACITE 7014 G85 78
	-	-		-	-	80	-	-	4	1	05213024	●	●	●	●	●

# CUBIC

design Leo De Carlo



## MANIGLIA PER ALZANTE SCORREVOLE - SUPPORTO 32x159x12mm\_LIFT&SLIDE HANDLE - SUPPORT 32x159x12mm

CARATTERISTICHE_FEATURES					FISSAGGIO_FIXING				FINITURE_FINISHES				OPZIONI_OPTIONS						

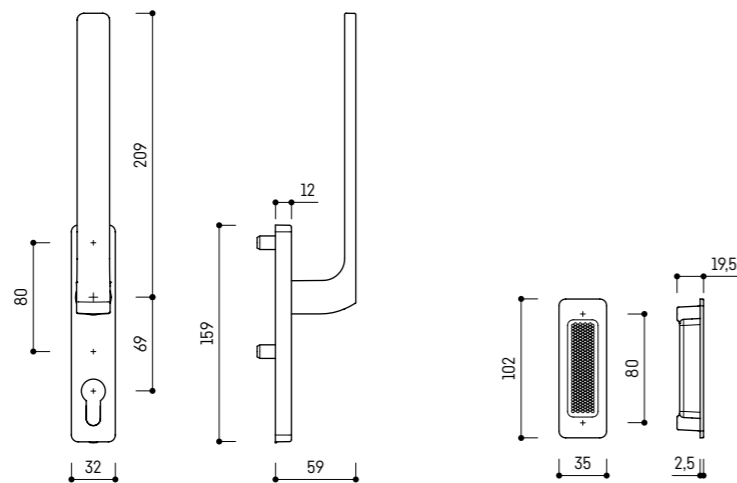
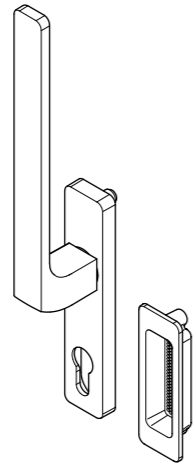

### VERSIONI DISPONIBILI\_AVAILABLE VERSIONS

### CAPITOLATO\_SPECIFICATION

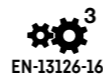

Per una descrizione dettagliata di tutte le specifiche tecniche presenti nel prodotto, da impiegare nei capitolati o nelle offerte pubbliche, fate riferimento alla sezione CAPITOLATI. For a detailed description of all the technical informations contained in the product, to be used in the specifications or in public tenders, please refer to the SPECIFICATIONS section.

NORMA EN 13126-16 \_EN 13126-16 NORM  
- 3 | 250 | 0 | 1 | 5 | - 16 | 1200 | 2000

# CUBIC

design Leo De Carlo



ZAMAK

Supporto\_Support

32x159x12mm (maniglia)

												MECHANISM						MECHANISM			
												62	50	03	04	5B	08	06	52	07	01
	10*			-	-	80	ø10x15	69	4	1	05919021	●	●	●	●	●	●	●	●	●	●
	10*			-	-	80	ø10x15	-	4	1	05919022	●	●	●	●	●	●	●	●	●	●
	10/75			75-80	M5x85 M5x90	80	ø10x15	69	4	1	05919023	●	●	●	●	●	●	●	●	●	●
	10/75			75-80	M5x85 M5x90	80	ø10x15	-	4	1	05919024	●	●	●	●	●	●	●	●	●	●

Opzioni\_Options

-



IRON

Supporto\_Support

Viti\_Screws

												MECHANISM												
												26												
	-	-		35-40	M5x45 M5x50	-	-	-	10	1	06828085	●	●	●	●	●	●	●	●	●	●	●	●	
	-	-		40-45	M5x50 M5x55	-	-	-	10	1	06828086	●	●	●	●	●	●	●	●	●	●	●	●	
	-	-		50-55	M5x60 M5x65	-	-	-	10	1	06828087	●	●	●	●	●	●	●	●	●	●	●	●	
	-	-		55-60	M5x65 M5x70	-	-	-	10	1	06828088	●	●	●	●	●	●	●	●	●	●	●	●	
	-	-		60-65	M5x70 M5x75	-	-	-	10	1	06828089	●	●	●	●	●	●	●	●	●	●	●	●	
	-	-		65-70	M5x75 M5x80	-	-	-	10	1	06828090	●	●	●	●	●	●	●	●	●	●	●	●	
	-	-		70-75	M5x80 M5x85	-	-	-	10	1	06828091	●	●	●	●	●	●	●	●	●	●	●	●	
	-	-		75-80	M5x85 M5x90	-	-	-	10	1	06828092	●	●	●	●	●	●	●	●	●	●	●	●	
	-	-		80-85	M5x90 M5x95	-	-	-	10	1	06828093	●	●	●	●	●	●	●	●	●	●	●	●	
	-	-		85-90	M5x95 M5x100	-	-	-	10	1	06828094	●	●	●	●	●	●	●	●	●	●	●	●	
	-	-		90-95	M5x100 M5x105	-	-	-	10	1	06828095	●	●	●	●	●	●	●	●	●	●	●	●	
	-	-		95-100	M5x105 M5x110	-	-	-	10	1	06828096	●	●	●	●	●	●	●	●	●	●	●	●	
	-	-		100-105	M5x110 M5x115	-	-	-	10	1	06828097	●	●	●	●	●	●	●	●	●	●	●	●	
	-	-		105-110	M5x115 M5x120	-	-	-	10	1	06828098	●	●	●	●	●	●	●	●	●	●	●	●	

Opzioni\_Options



IRON

Supporto\_Support

Ferro per maniglione singolo\_Spindle for single L&amp;S handle

												MECHANISM 26
10/35	-	-	35-40	-	-	-	-	-	10	1	06727468	●
10/40	-	-	40-45	-	-	-	-	-	10	1	06727469	●
10/50	-	-	50-55	-	-	-	-	-	10	1	06727470	●
10/55	-	-	55-60	-	-	-	-	-	10	1	06727471	●
10/60	-	-	60-65	-	-	-	-	-	10	1	06727166	●
10/65	-	-	65-70	-	-	-	-	-	10	1	06727472	●
10/70	-	-	70-75	-	-	-	-	-	10	1	06727473	●
10/75	-	-	75-80	-	-	-	-	-	10	1	06727340	●
10/80	-	-	80-85	-	-	-	-	-	10	1	06727474	●
10/85	-	-	85-90	-	-	-	-	-	10	1	06727475	●
10/90	-	-	90-95	-	-	-	-	-	10	1	06727399	●
10/95	-	-	95-100	-	-	-	-	-	10	1	06727476	●
10/100	-	-	100-105	-	-	-	-	-	10	1	06727477	●
10/105	-	-	105-110	-	-	-	-	-	10	1	06727137	●

Opzioni\_Options



IRON

Supporto\_Support

Ferro + viti per L&amp;S doppio\_Spindle + screws for double L&amp;S

												MECHANISM 26
10/85	-	-	35-40	M5x35	M5x40	-	-	-	10	1	06727478	●
10/95	-	-	40-45	M5x40	M5x45	-	-	-	10	1	06727479	●
10/100	-	-	45-50	M5x45	M5x50	-	-	-	10	1	06727480	●
10/105	-	-	50-55	M5x50	M5x55	-	-	-	10	1	06727481	●
10/110	-	-	55-60	M5x55	M5x60	-	-	-	10	1	06727482	●
10/115	-	-	60-65	M5x60	M5x65	-	-	-	10	1	06727483	●
10/120	-	-	65-70	M5x65	M5x70	-	-	-	10	1	06727484	●
10/125	-	-	70-75	M5x70	M5x75	-	-	-	10	1	06727485	●
10/130	-	-	75-80	M5x75	M5x80	-	-	-	10	1	06727486	●
10/135	-	-	80-85	M5x80	M5x85	-	-	-	10	1	06727487	●
10/140	-	-	85-90	M5x85	M5x90	-	-	-	10	1	06727488	●
10/145	-	-	90-95	M5x90	M5x95	-	-	-	10	1	06727489	●
10/150	-	-	95-100	M5x95	M5x100	-	-	-	10	1	06727490	●
10/155	-	-	100-105	M5x100	M5x105	-	-	-	10	1	06727491	●

## Maniglia doppia\_Double handle

design Leo De Carlo



ZAMAK

Supporto\_Support

32x159x12mm

													PLATINUM 62	
													BLACK PEARL 50	
													PLATINUM 03	
													BLACK PEARL 04	
													COPPER PEARL 5B	
													NOIR PEARL 08	
													ANTIQUÉ GOLD 06	
													COPPER SHINING 52	
													CRYSTAL SHINING 07	
													GOLD SHINING 01	
10/128			75-80	M5x90	80	ø10x15	69	4	1	05919042	●	●	●	●

Maniglietta da incasso singola  
Single recessed handle

design Leo De Carlo



ZAMAK

Supporto\_Support

32x102x2,5mm

													PLATINUM 62	
													BLACK PEARL 50	
													PLATINUM 03	
													BLACK PEARL 04	
													COPPER PEARL 5B	
													NOIR PEARL 08	
													ANTIQUÉ GOLD 06	
													COPPER SHINING 52	
													CRYSTAL SHINING 07	
													GOLD SHINING 01	
													NATURAL GOLD 52	
													WHITE PEARL 02	
-	-		-	-	80	-	-	4	1	05213026	●	●	●	●

# CUBIC

design Leo De Carlo



MANIGLIA PER ALZANTE SCORREVOLE - SUPPORTO 32x159x12mm\_LIFT&SLIDE HANDLE - SUPPORT 32x159x12mm

CARATTERISTICHE_FEATURES					FISSAGGIO_FIXING					FINITURE_FINISHES					OPZIONI_OPTIONS				
										CLASS 5	CLASS 5	CLASS 5	CLASS 5	CLASS 5	CLASS 5	+	REI-60	EN-179	IP-65

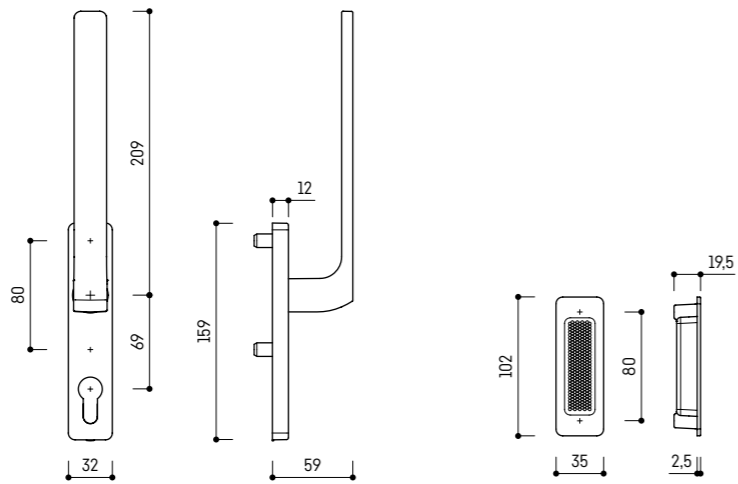
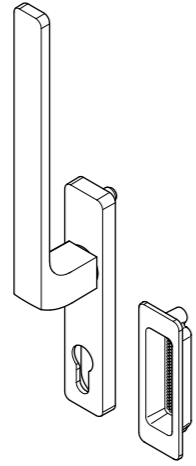

## VERSIONI DISPONIBILI\_AVAILABLE VERSIONS

VERSIONI DISPONIBILI_AVAILABLE VERSIONS					CAPITOLATO_SPECIFICATION
					<p>Per una descrizione dettagliata di tutte le specifiche tecniche presenti nel prodotto, da impiegare nei capitolati o nelle offerte pubbliche, fate riferimento alla sezione CAPITOLATI. For a detailed description of all the technical informations contained in the product, to be used in the specifications or in public tenders, please refer to the SPECIFICATIONS section.</p> <p><b>NORMA EN 13126-16</b> _EN 13126-16 NORM                      - 3   250   0   1   5   - 16   1200   2000</p>

# CUBIC

design Leo De Carlo



ALU

Supporto\_Support

32x159x12mm (maniglia)

													MECHANISM				
													F1	F9	BLACK MATT 9006 G6	WHITE SIGNAL 9006 G85	ANTHRACITE 7006 G85
													97	48	33	22	78
	10*			-	-	80	ø10x15	69	4	1	05919033						
	10*			-	-	80	ø10x15	-	4	1	05919034						
	10/75			75-80	M5x85 M5x90	80	ø10x15	69	4	1	05919035						
	10/75			75-80	M5x85 M5x90	80	ø10x15	-	4	1	05919036						

Opzioni\_Options

-



IRON

Supporto\_Support

Viti per maniglione singolo\_Screws for single L&S handle

													MECHANISM	
													26	
	-	-		35-40	M5x45 M5x50	-	-	-	10	1	06828085			
	-	-		40-45	M5x50 M5x55	-	-	-	10	1	06828086			
	-	-		50-55	M5x60 M5x65	-	-	-	10	1	06828087			
	-	-		55-60	M5x65 M5x70	-	-	-	10	1	06828088			
	-	-		60-65	M5x70 M5x75	-	-	-	10	1	06828089			
	-	-		65-70	M5x75 M5x80	-	-	-	10	1	06828090			
	-	-		70-75	M5x80 M5x85	-	-	-	10	1	06828091			
	-	-		75-80	M5x85 M5x90	-	-	-	10	1	06828092			
	-	-		80-85	M5x90 M5x95	-	-	-	10	1	06828093			
	-	-		85-90	M5x95 M5x100	-	-	-	10	1	06828094			
	-	-		90-95	M5x100 M5x105	-	-	-	10	1	06828095			
	-	-		95-100	M5x105 M5x110	-	-	-	10	1	06828096			
	-	-		100-105	M5x110 M5x115	-	-	-	10	1	06828097			
	-	-		105-110	M5x115 M5x120	-	-	-	10	1	06828098			



Opzioni\_Options



IRON

Supporto\_Support

Ferro per maniglione singolo\_Spindle for single L&amp;S handle

												MECHANISM 26
10/35	-	-	35-40	-	-	-	-	10	1	06727468		●
10/40	-	-	40-45	-	-	-	-	10	1	06727469		●
10/50	-	-	50-55	-	-	-	-	10	1	06727470		●
10/55	-	-	55-60	-	-	-	-	10	1	06727471		●
10/60	-	-	60-65	-	-	-	-	10	1	06727466		●
10/65	-	-	65-70	-	-	-	-	10	1	06727472		●
10/70	-	-	70-75	-	-	-	-	10	1	06727473		●
10/75	-	-	75-80	-	-	-	-	10	1	06727340		●
10/80	-	-	80-85	-	-	-	-	10	1	06727474		●
10/85	-	-	85-90	-	-	-	-	10	1	06727475		●
10/90	-	-	90-95	-	-	-	-	10	1	06727399		●
10/95	-	-	95-100	-	-	-	-	10	1	06727476		●
10/100	-	-	100-105	-	-	-	-	10	1	06727477		●
10/105	-	-	105-110	-	-	-	-	10	1	06727137		●

## Maniglia doppia\_Double handle

design Leo De Carlo



ALU

Supporto\_Support

32x159x12mm

												F1 97	P2 48	BLACK MATT 9016 G6 33	WHITE SIGNAL 9014 G85 22	ANTHRACITE 7014 G85 78
10/128			75-80	M5x90	80	ø10x15	69	4	1	05919045	●	●	●	●	●	

Opzioni\_Options



IRON

Supporto\_Support

Ferro + viti per L&amp;S doppio\_Spindle + screws for double L&amp;S

											MECHANISM 26
10/85	-	-	35-40	M5x35 M5x40	-	-	-	10	1	06727478	●
10/95	-	-	40-45	M5x40 M5x45	-	-	-	10	1	06727479	●
10/100	-	-	45-50	M5x45 M5x50	-	-	-	10	1	06727480	●
10/105	-	-	50-55	M5x50 M5x55	-	-	-	10	1	06727481	●
10/110	-	-	55-60	M5x55 M5x60	-	-	-	10	1	06727482	●
10/115	-	-	60-65	M5x60 M5x65	-	-	-	10	1	06727483	●
10/120	-	-	65-70	M5x65 M5x70	-	-	-	10	1	06727484	●
10/125	-	-	70-75	M5x70 M5x75	-	-	-	10	1	06727485	●
10/130	-	-	75-80	M5x75 M5x80	-	-	-	10	1	06727486	●
10/135	-	-	80-85	M5x80 M5x85	-	-	-	10	1	06727487	●
10/140	-	-	85-90	M5x85 M5x90	-	-	-	10	1	06727488	●
10/145	-	-	90-95	M5x90 M5x95	-	-	-	10	1	06727489	●
10/150	-	-	95-100	M5x95 M5x100	-	-	-	10	1	06727490	●
10/155	-	-	100-105	M5x100 M5x105	-	-	-	10	1	06727491	●

Manigletta da incasso singola  
Single recessed handle

design Leo De Carlo



ALU

Supporto\_Support

32x102x2,5mm

									F1 97	P2 48	BLACK MATT 9016 G6 33	WHITE SIGNAL 9014 G85 22	ANTHRACITE 7014 G85 78	
	-	-		-	-	80	-	4	1	05213024	●	●	●	●



MANIGLIA PER ALZANTE SCORREVOLE - SUPPORTO 32x159x12mm\_LIFT&SLIDE HANDLE - SUPPORT 32x159x12mm

CARATTERISTICHE_FEATURES					FISSAGGIO_FIXING					FINITURE_FINISHES					OPZIONI_OPTIONS				
					CLASS 5					CLASS 5					REI-60 EN-179 IP-65				

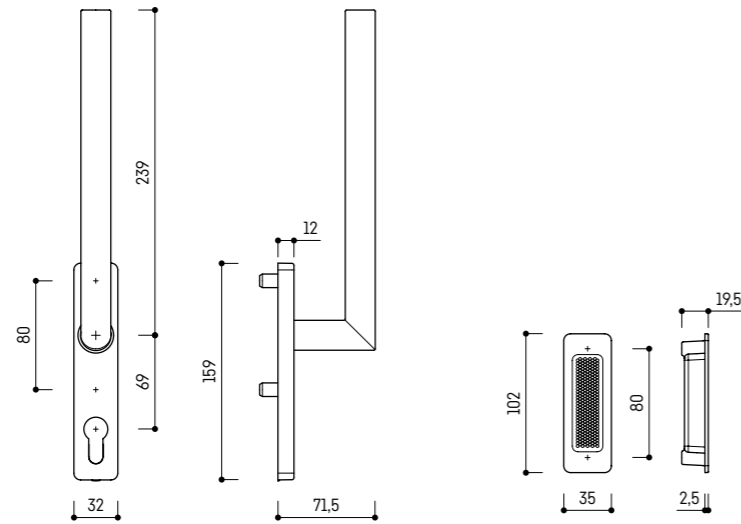
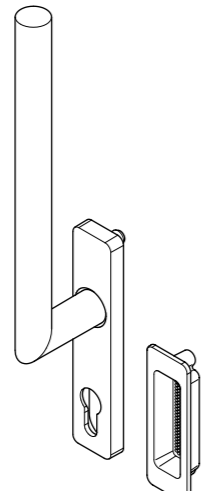

VERSIONI DISPONIBILI\_AVAILABLE VERSIONS

VERSIONI DISPONIBILI_AVAILABLE VERSIONS					CAPITOLATO_SPECIFICATION <sup>3</sup> EN-13126-16
					<p>Per una descrizione dettagliata di tutte le specifiche tecniche presenti nel prodotto, da impiegare nei capitolati o nelle offerte pubbliche, fate riferimento alla sezione CAPITOLATI. For a detailed description of all the technical informations contained in the product, to be used in the specifications or in public tenders, please refer to the SPECIFICATIONS section.</p> <p>NORMA EN 13126-16_EN 13126-16 NORM - 3   250   0   1   5   - 16   1200   2000</p>



	10*			-	-	80	ø10x15	69	4	1	05919037								
	10*			-	-	80	ø10x15	-	4	1	05919038								
	10/75			75-80	M5x85 M5x90	80	ø10x15	69	4	1	05919039								
	10/75			75-80	M5x85 M5x90	80	ø10x15	-	4	1	05919040								

Opzioni\_Options

-



IRON

	-			35-40	M5x45 M5x50	-	-	-	10	1	06828085								
	-			40-45	M5x50 M5x55	-	-	-	10	1	06828086								
	-			50-55	M5x60 M5x65	-	-	-	10	1	06828087								
	-			55-60	M5x65 M5x70	-	-	-	10	1	06828088								
	-			60-65	M5x70 M5x75	-	-	-	10	1	06828089								
	-			65-70	M5x75 M5x80	-	-	-	10	1	06828090								
	-			70-75	M5x80 M5x85	-	-	-	10	1	06828091								
	-			75-80	M5x85 M5x90	-	-	-	10	1	06828092								
	-			80-85	M5x90 M5x95	-	-	-	10	1	06828093								
	-			85-90	M5x95 M5x100	-	-	-	10	1	06828094								
	-			90-95	M5x100 M5x105	-	-	-	10	1	06828095								
	-			95-100	M5x105 M5x110	-	-	-	10	1	06828096								
	-			100-105	M5x110 M5x115	-	-	-	10	1	06828097								
	-			105-110	M5x115 M5x120	-	-	-	10	1	06828098								

Opzioni\_Options



IRON

Supporto\_Support

Ferro per maniglione singolo\_Spindle for single L&amp;S handle

												MECHANISM 26
10/35	-	-	35-40	-	-	-	-	10	1	06727468		●
10/40	-	-	40-45	-	-	-	-	10	1	06727469		●
10/50	-	-	50-55	-	-	-	-	10	1	06727470		●
10/55	-	-	55-60	-	-	-	-	10	1	06727471		●
10/60	-	-	60-65	-	-	-	-	10	1	06727166		●
10/65	-	-	65-70	-	-	-	-	10	1	06727472		●
10/70	-	-	70-75	-	-	-	-	10	1	06727473		●
10/75	-	-	75-80	-	-	-	-	10	1	06727340		●
10/80	-	-	80-85	-	-	-	-	10	1	06727474		●
10/85	-	-	85-90	-	-	-	-	10	1	06727475		●
10/90	-	-	90-95	-	-	-	-	10	1	06727399		●
10/95	-	-	95-100	-	-	-	-	10	1	06727476		●
10/100	-	-	100-105	-	-	-	-	10	1	06727477		●
10/105	-	-	105-110	-	-	-	-	10	1	06727137		●

## Maniglia doppia\_Double handle

design Leo De Carlo



AISI304

Supporto\_Support

32x159x12mm

												AISI304 19	BLACK PEARL 04	COPPER PEARL 58	NOIR PEARL 08	ANTIQUÉ GOLD 06
10/128			75-80	M5x90	80	ø10x15	69	4	1	05919046	●	●	●	●	●	

Maniglietta da incasso singola  
Single recessed handle

design Leo De Carlo



AISI304

Supporto\_Support

32x102x2,5mm

												PLATINUM 62	BLACK PEARL 50	PLATINUM 03	BLACK PEARL 04	COPPER PEARL 58	NOIR PEARL 08	ANTIQUÉ GOLD 06	COPPER SHINING 52	CRYSTAL SHINING 07	GOLD SHINING 01	NATURAL GOLD 52	WHITE PEARL 02		
												80	-	-	4	1	05213026	●	●	●	●	●	●	●	●